

DUEGI srl
Via Delle Crede 10G
33170 - Pordenone (PN)
t: +390434604119
info@duegilight.com
P. IVA 01669240937
www.duegilight.com

DUEGI.CA.002.2024



SOLUZIONI ILLUMINOTECNICHE
BROCHURE





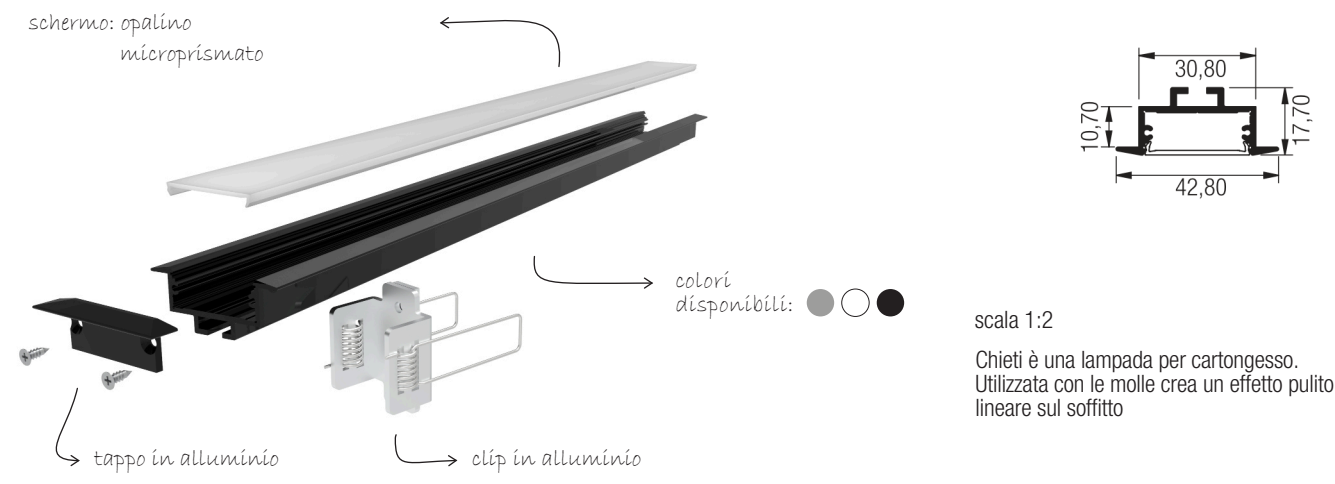



Lampade cartongesso



Applicazioni



COMBINAZIONI DISPONIBILI

POTENZA	VOLT	LUMEN	CCT	INTERRUTTORI
19.2 watt/mt	24 V	2500/2785 lm/mt	3000/4000 K	     
25 watt/mt	24 V	3000/3125/3250 lm/mt	2700/3000/4000 K	
RGB+WW	24 V			
12 watt/mt	48 V	1400/1520/1630 lm/mt	2700/3000/4000 K	
20 watt/mt	48 V	2050/2160/2250 lm/mt	2700/3000/4000 K	